

ABE7R16M111

Sub-base with plug-in electromechanical relay ABE7, 16 channels, relay 5 mm



Product availability: Non-Stock - Not normally stocked in distribution facility

Price*: 675.00 USD

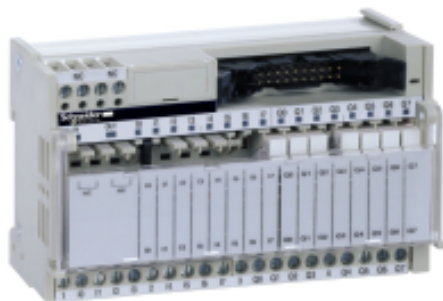

Main

Range of product	Modicon ABE7
Product or component type	Sub-base with plug-in electromechanical relay
Sub-base type	Output sub-base
[Us] rated supply voltage	19...30 V IEC 61131-2
Number of channels	16
Connections - terminals	Screw type terminals, 1 x 0.14...1 x 1.5 mm ² AWG 26...AWG 16) flexible with cable end Screw type terminals, 1 x 0.14...1 x 2.5 mm ² AWG 26...AWG 14) flexible without cable end Screw type terminals, 1 x 0.14...1 x 4 mm ² AWG 26...AWG 12) solid Screw type terminals, 2 x 0.14...2 x 0.75 mm ² AWG 26...AWG 18) flexible with cable end Screw type terminals, 2 x 0.14...2 x 1.5 mm ² AWG 26...AWG 16) solid

Complementary

Supply circuit type	DC
Product compatibility	ABR7S11
Contacts type and composition	1 NO
Status LED	Power ON 1 LED Channel status 1 LED per channel
Polarity distribution	Common distribution group of 4 + 2 inputs common terminals
Short-circuit protection	1 A internal fuse, 5 x 20 mm, fast blow PLC end)
Mounting mode	By clips 35 mm DIN rail) By screws surface mount with kit)
Maximum supply current	1 A
Voltage drop on power supply fuse	0.3 V
Maximum current per output common	5 A screw type terminals
[Ui] rated insulation voltage	2000 V terminals/mounting rails 300 V coil circuit/contact circuits IEC 60947-1
Maximum current per module	12 A
[Uimp] rated impulse withstand voltage	2.5 KV
Installation category	II IEC 60664-1

Tightening torque	5.31 Lbf.In (0.6 N.m) flat Ø 3.5 mm
Net weight	1.32 Lb(US) (0.6 kg)

Environment

Product certifications	UL DNV BV CSA GL LROS (Lloyds register of shipping) EAC
IP degree of protection	IP2x conforming to IEC 60529
Resistance to incandescent wire	1382 °F (750 °C) 30 s IEC 60695-2-11
Shock resistance	15 gn 11 ms IEC 60068-2-27
Vibration resistance	2 gn 10...150 Hz)IEC 60068-2-6
Resistance to electrostatic discharge	4 KV contact) level 3 IEC 61000-4-2 8 KV air) level 3 IEC 61000-4-2
Resistance to radiated fields	9.14 V/M (10 V/m) 26000000...100000000 Hz)IEC 61000-4-3 level 3
Resistance to fast transients	2 KV level 3 IEC 61000-4-4
Ambient air temperature for operation	23...140 °F (-5...60 °C) IEC 61131-2
Ambient air temperature for storage	-40...176 °F (-40...80 °C) IEC 61131-2
Pollution degree	2 IEC 60664-1

Ordering and shipping details

Category	22375 - INTERFACE MODULE(ABA,R,S)
Discount Schedule	CP2
GTIN	03389110251067
Nbr. of units in pkg.	1
Package weight(Lbs)	9.45 Oz (268 g)
Returnability	No
Country of origin	FR

Packing Units

Unit Type of Package 1	PCE
Package 1 Height	2.76 In (7 cm)
Package 1 width	3.23 In (8.2 cm)
Package 1 Length	5.43 In (13.8 cm)

Offer Sustainability

Sustainable offer status	Green Premium product
California proposition 65	WARNING: This product can expose you to chemicals including: Lead and lead compounds, which is known to the State of California to cause cancer and birth defects or other reproductive harm. For more information go to www.P65Warnings.ca.gov
REACH Regulation	REACH Declaration
REACH free of SVHC	Yes
EU RoHS Directive	Pro-active compliance (Product out of EU RoHS legal scope) EU RoHS Declaration
Mercury free	Yes
RoHS exemption information	Yes
China RoHS Regulation	China RoHS Declaration
Environmental Disclosure	Product Environmental Profile

Circularity Profile	End Of Life Information
WEEE	The product must be disposed on European Union markets following specific waste collection and never end up in rubbish bins.

Contractual warranty

Warranty	18 months
----------	-----------

Dimensions

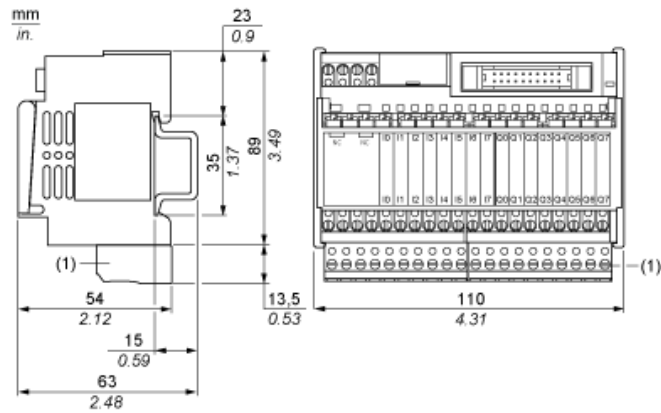

(1) ABE7BV10 / BV20

Mounting

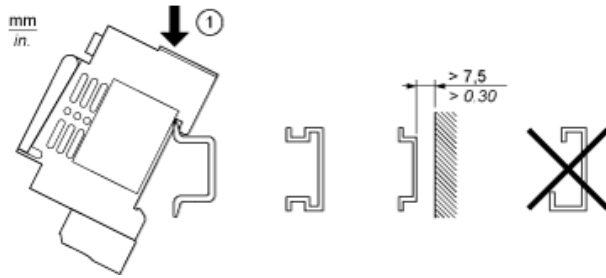

Wiring channels

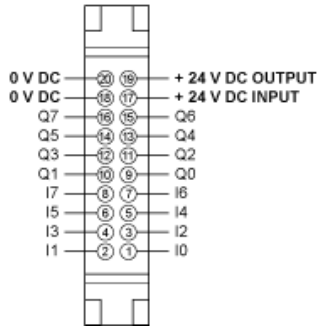

Qx Outputs
Ix Inputs

Wiring Diagram

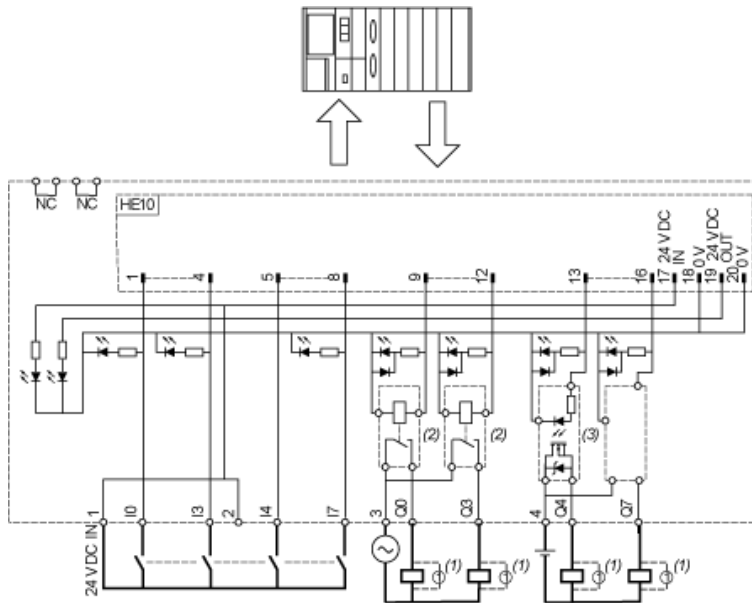

- (1) Inductive load
- (2) ABR7S11 (1F) - N/O Ith = 6 A (supplied for ABE7R16M111 and not supplied for ABE7P16M111)
- (3) ABS7SC1B 24 VDC I_{max.} = 2 A (not supplied)

Curves for Determining Cable Type and Length According to the Current

16-channel Sub-base

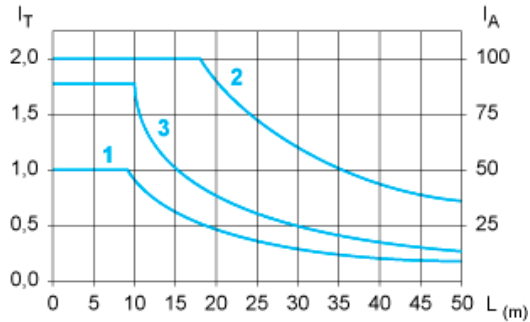

L Cable length

I_T Total current per sub base (A)

I_A Average current per channel (mA)

(1) TSXCDP••2 and ABFH20H••0 cables with c.s.a. 0.08 mm^2 (AWG 28).

(2) TSXCDP••3 cables with c.s.a. 0.34 mm^2 (AWG 22).

(3) Cables with c.s.a. 0.13 mm^2 (AWG 26).

The curves are given for a voltage drop of 1 V in the cable. For n volts tolerance, multiply the length determined from the graph by n.

Electrical Durability (in Millions of Operating Cycles) Conforming to IEC 60947-5-1

DC Loads

DC12 curves

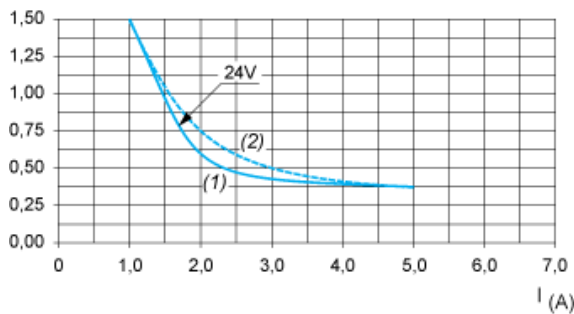

DC12control of resistive loads and of solid state loads isolated by optocoupler, $I/R \leq 1 \text{ ms}$.

(1) Resistive loads

(2) Inductive loads

DC13 curves

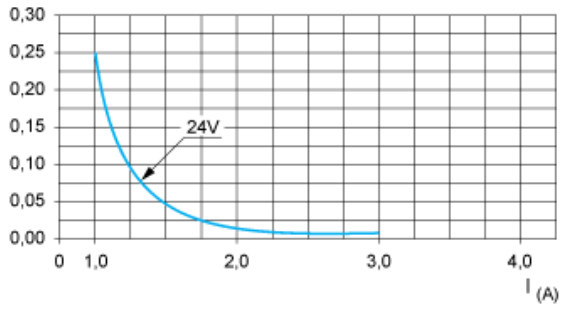

DC13switching electromagnets, $L/R \leq 2 \times (U_e \times I_e)$ in ms, U_e : rated operational voltage, I_e : rated operational current (with a protective diode on the load, DC12 c

AC Loads

AC12 curves

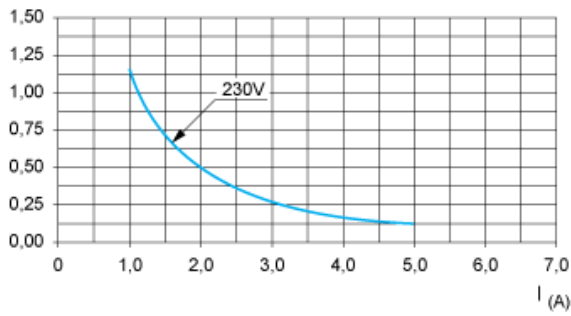

AC12control of resistive loads and of solid state loads isolated by optocoupler, $\cos \phi \geq 0.9$.

AC15 curves

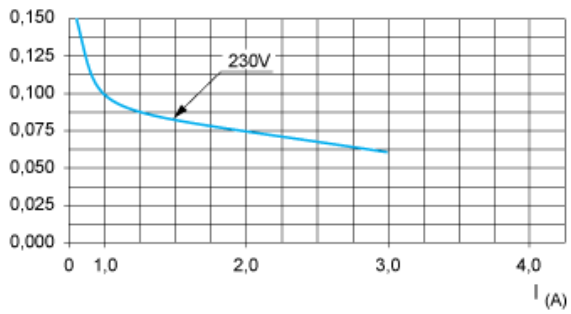

AC15control of electromagnetic loads $> 72 \text{ VA}$, make: $\cos \phi = 0.7$, break: $\cos \phi = 0.4$.

Product Life Status : **Commercialised**